

Short Tutorial on MPEG-DASH

Dynamic Adaptive Streaming Over Internet

ISO/IEC 23009-1

MPEG DASH Subgroup

MPEG-DASH ISO/IEC 23009-1

- ▶ Provides a superset for system specifications
 - ▶ 3GPP Release-9 AHS in TS 26.234 and 3GPP Release-10 DASH TS26.247
 - ▶ Open IPTV Forum HTTP Adaptive Streaming (HAS)
 - ▶ System specifications may define more: codecs, DRM, etc.
- ▶ Timeline and Activities
 - ▶ Draft International Standard (DIS) 23009-1 available publicly
 - ▶ 2 months balloting period until October 2011
 - ▶ Parallel approval process for extensions to ISO base media FF to support DASH
 - ▶ Continuous coordination with 3GPP and other organizations (DECE, OIPF, etc.)
 - ▶ Conformance and Reference Software activities kicked off (see WD 23009-2)

MPEG-DASH Standard Development

Stage	Steps	Approval Process	Timeline (date of issue)
Exploration	1 st Workshop on MMT	-	July 2009
	1 st Draft CFP	-	October 2009
	2 nd Workshop on MMT	-	January 2010
Committee Stage	Call for Proposals	MPEG consensus	April 2010
	Working Draft	MPEG consensus	July 2010
	Committee Draft	SC29 Ballot	October 2010
Approval Stage	Draft International Standard	JTC1 Ballot	January 2011
	2 nd Draft International Standard	JTC1 Ballot	August 2011
	International Standard (submit for publication)		Dec 2011 (expected)

DASH is an example of developing the standard in the shortest time possible.

Adaptive Dynamic Streaming Simple Use Case

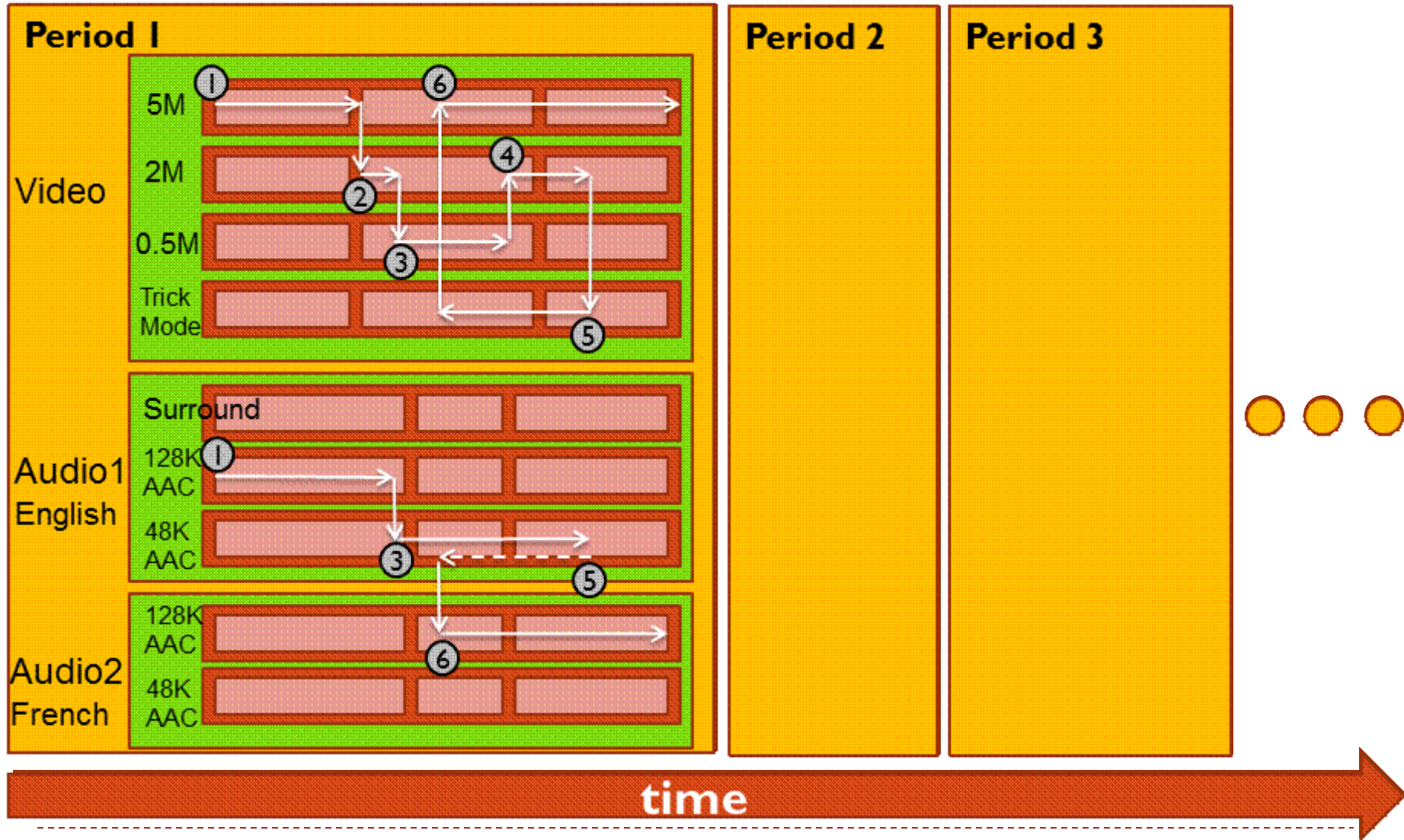

MPEG-DASH Design Principles

- ▶ DASH is an **enabler**
 - ▶ provides **formats** to enable efficient and high-quality streaming over the Internet
 - ▶ System definition left to other organizations (SDOs, Fora, Companies, etc.)
- ▶ DASH is not:
 - ▶ system, protocol, presentation, codec, middleware, client specification
- ▶ It attempts to be very good in what is to be addressed by the standard
 - ▶ Enables reuse of existing technologies (containers, codecs, DRM etc.)
 - ▶ Enables deployment on top of HTTP-CDNs (Web Infrastructures, caching)
 - ▶ Enables very high user-experience (low start-up, no rebuffering, trick modes)
 - ▶ Enables selection based on network and device capability, user preferences
 - ▶ Enables seamless switching
 - ▶ Enables live and DVD-kind of experiences
 - ▶ addresses global and regulatory deployment issues
 - ▶ Moves intelligence from network to client, enables client differentiation
 - ▶ Enables deployment flexibility (e.g., live, on-demand, time-shift viewing)
 - ▶ Provide simple interoperability points (profiles)
 - ▶ Provides convergence with existing proprietary technologies in this space

What is specified – and what is not?

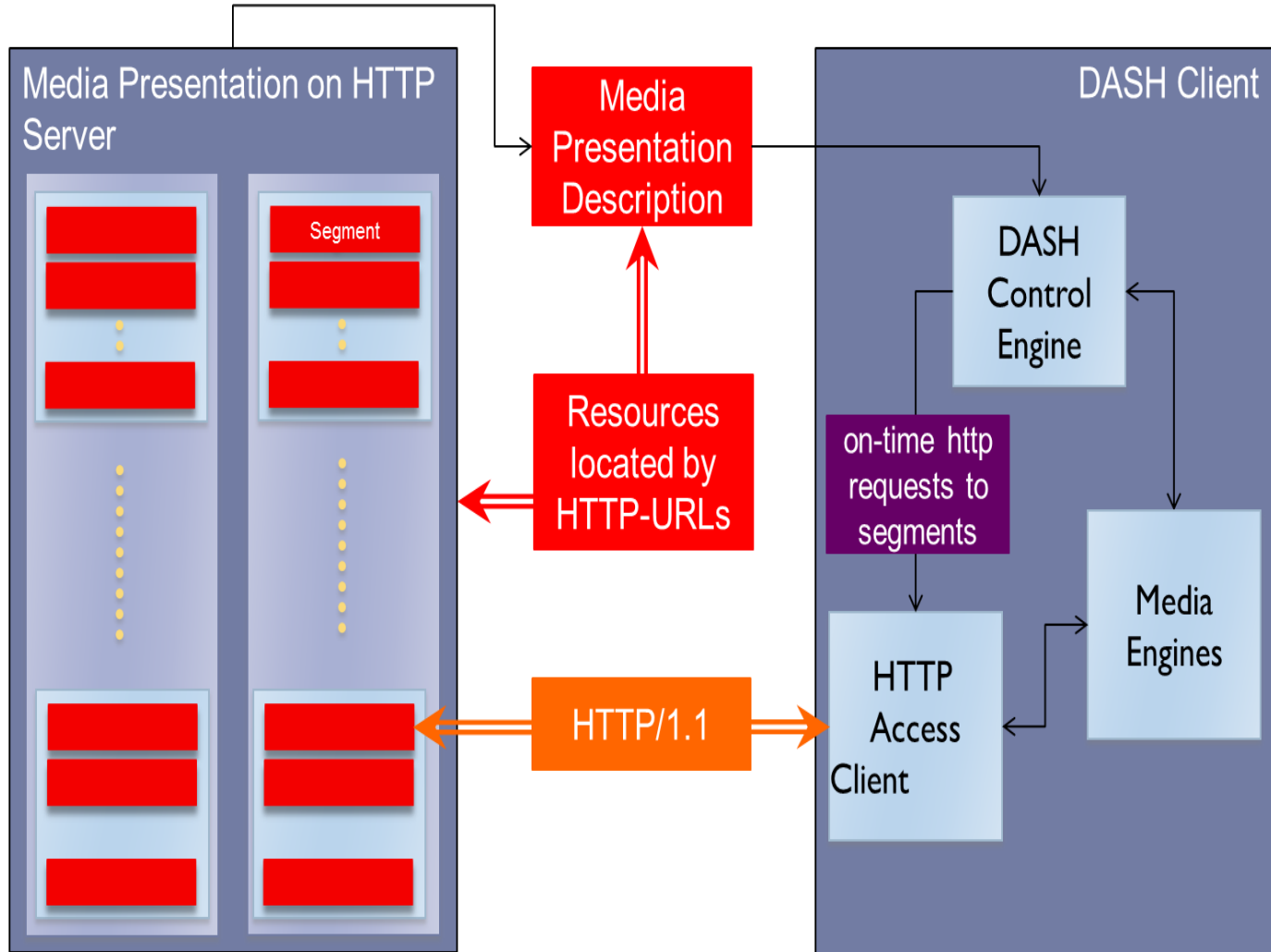

Information Classification

- ▶ MPD and Index Information for DASH Access client
 - ▶ Core specification aspects of DASH
- ▶ Initialization and Media Segments for Media engine
 - ▶ Reuse of existing container formats and easy conversion
 - ▶ Small adaptations may be necessary for usage in DASH

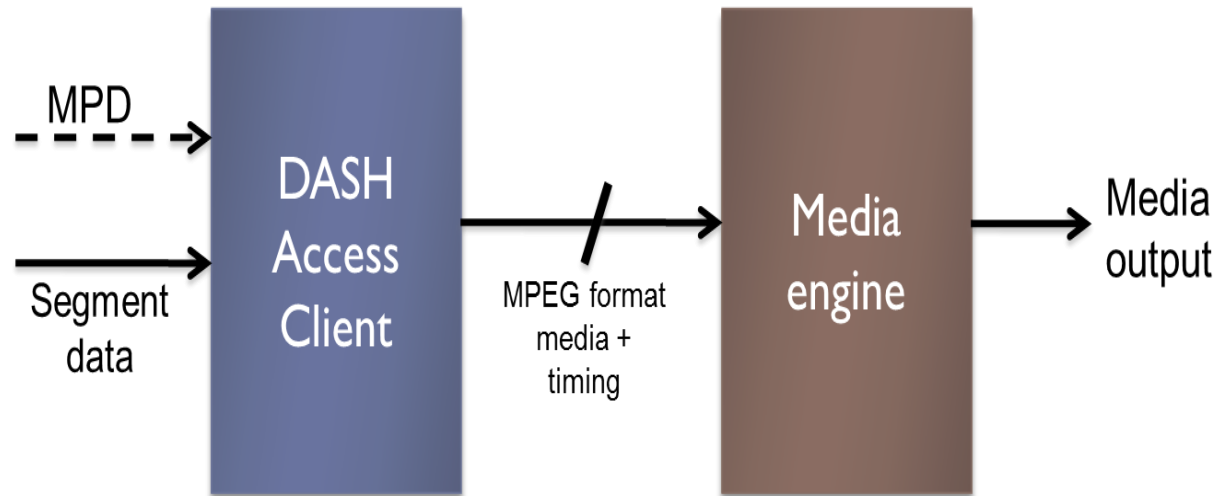

Media Presentation Description (MPD) Data Model

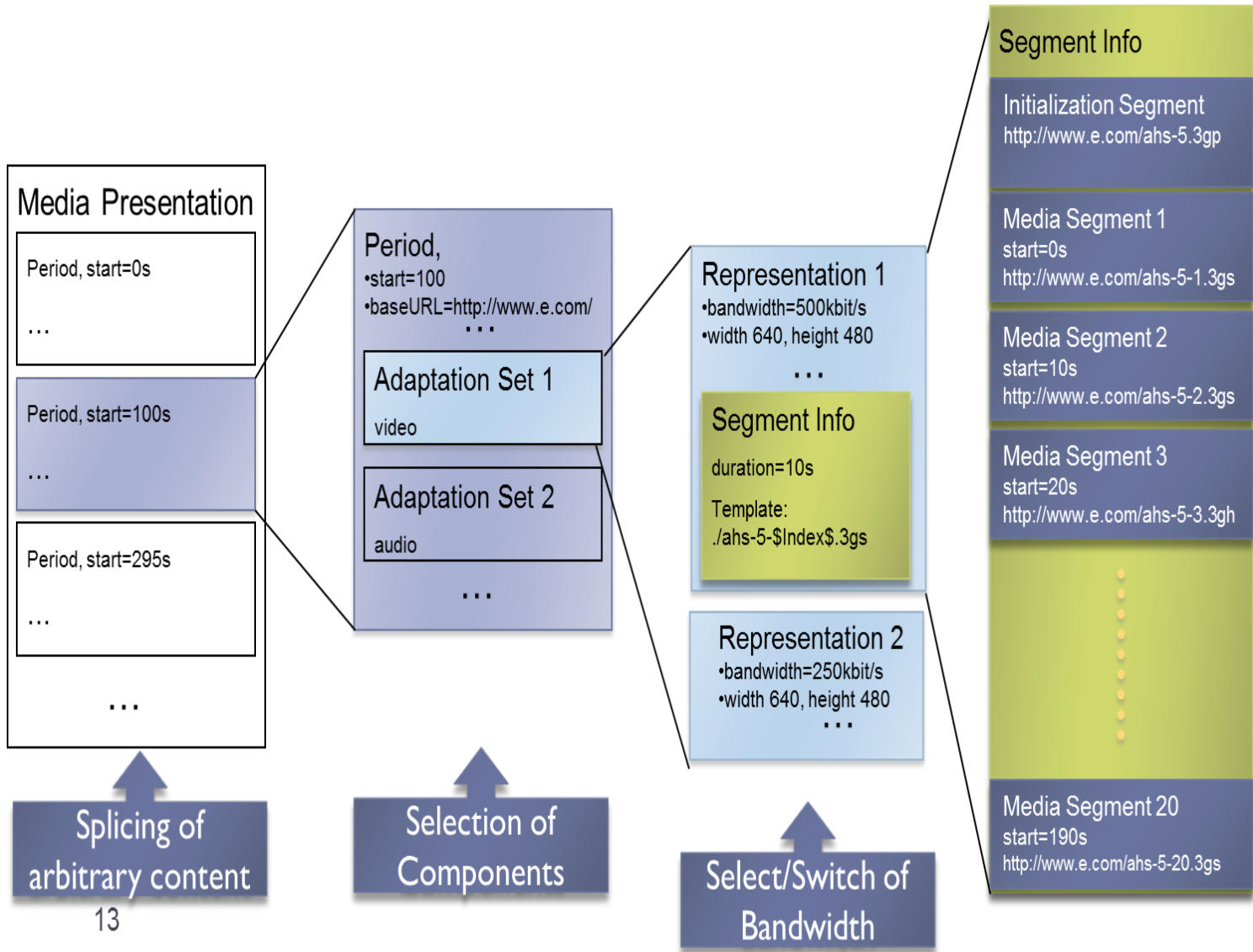

MPD Schema Overview

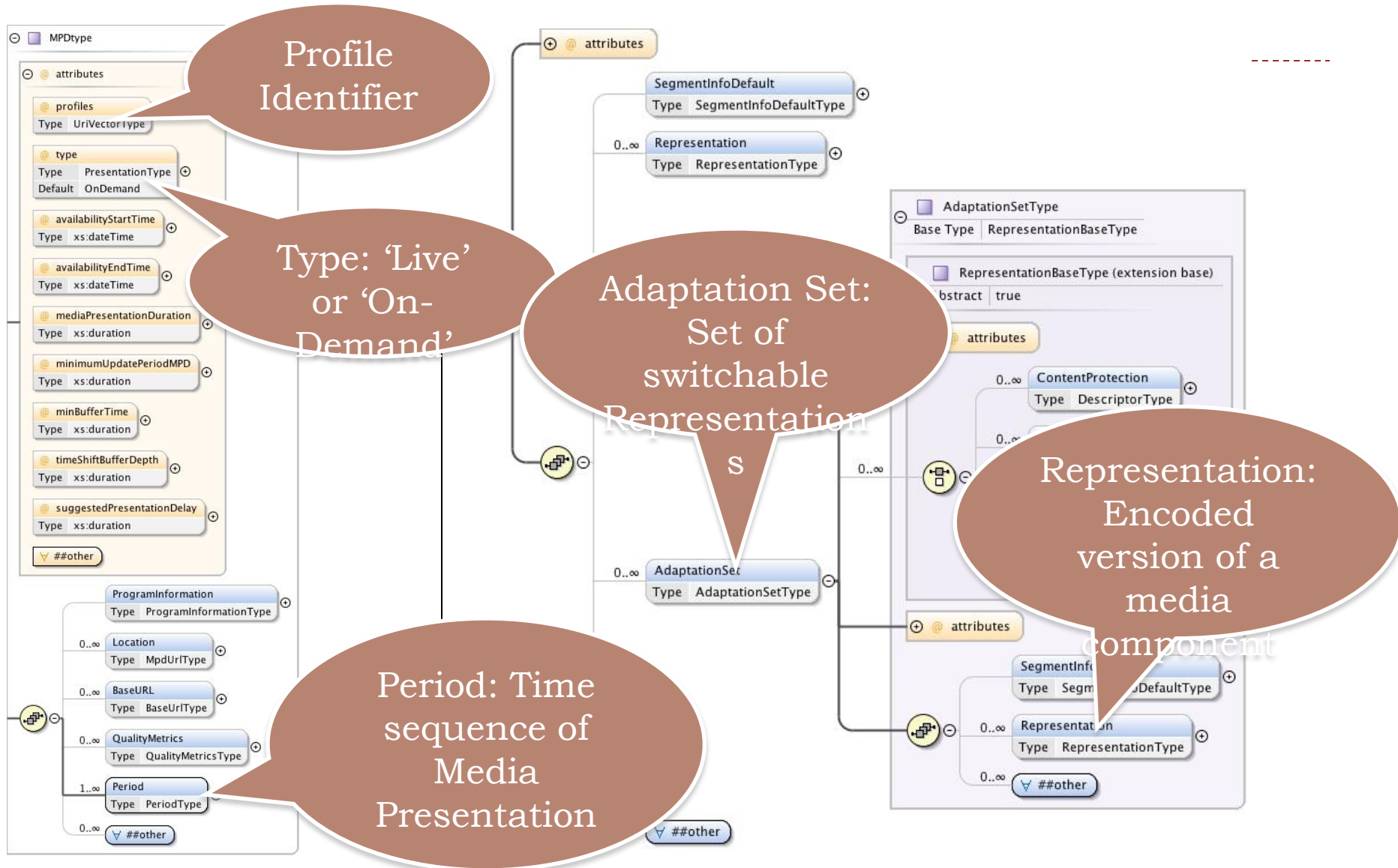

MPD Schema - Representation

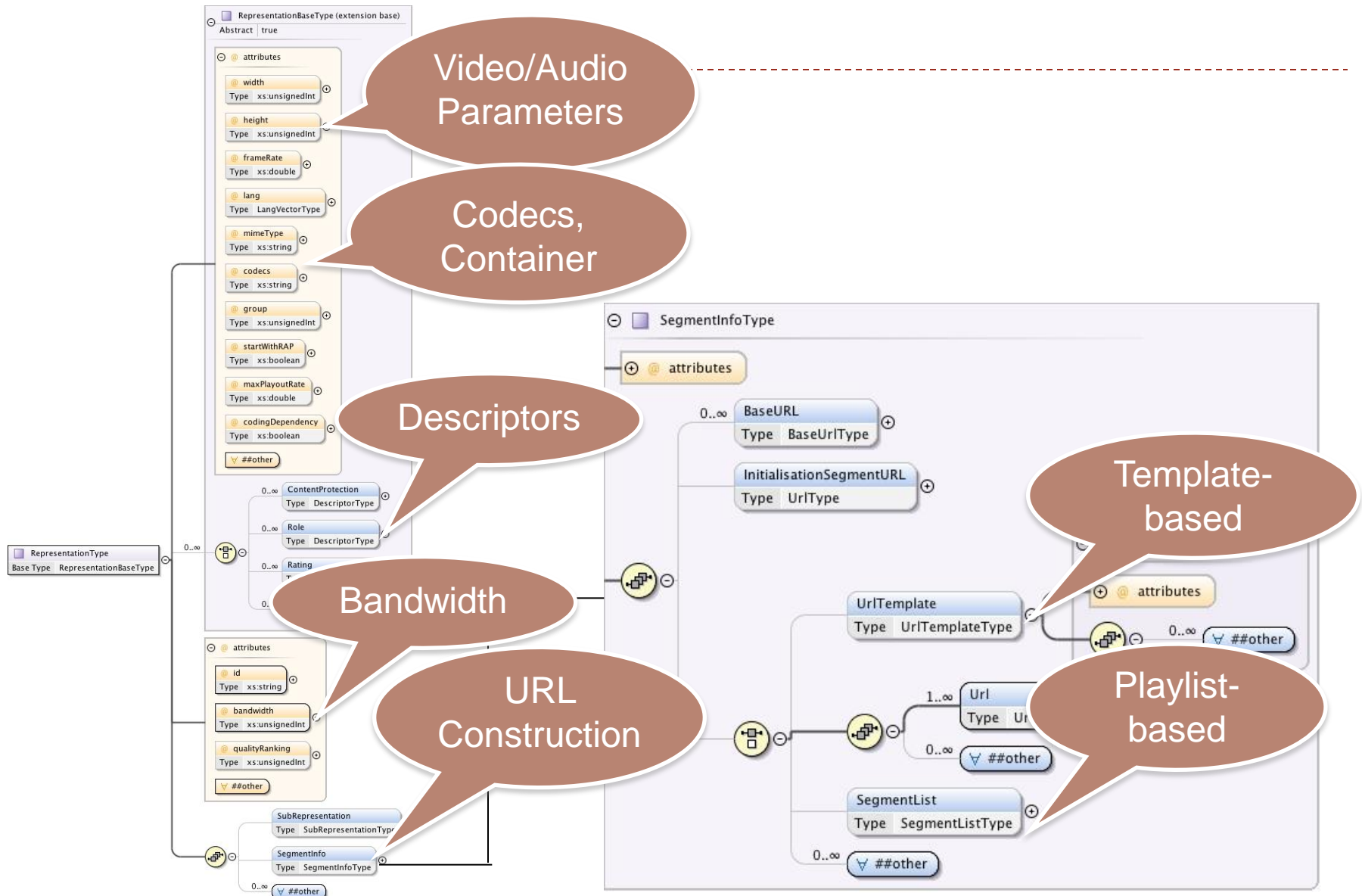

MPD Information

- ▶ Information of Media Streams for the purpose to initially select or reject Representations
 - ▶ Examples: Codec, DRM, language, resolution, bandwidth
- ▶ Access and Timing Information
 - ▶ the HTTP-URL(s) and byte range for each accessible Segment
 - ▶ the earliest next update of the MPD on the server
 - ▶ the segment availability start and end time in wall-clock time
 - ▶ the approximated media start time and duration of a Media Segment
 - ▶ for live service, instructions on starting playout such that media segments will be available in time for fluent playout in the future
- ▶ Switching and splicing relationships across Representations

Segment Indexing

- ▶ Provides binary information in ISO box structure on
 - ▶ Accessible units of data in a media segment
 - ▶ Each unit is described by
 - ▶ Byte range in the segments (easy access by HTTP partial GET)
 - ▶ Accurate presentation duration (seamless switching)
 - ▶ Presence of representation access positions, e.g. IDR frames
- ▶ Provides a compact bitrate-over-time profile to client
 - ▶ Can be used for intelligent request scheduling
- ▶ Generic Data Structure usable for any media segment format, e.g. ISO BMFF, MPEG-2 TS, etc.
- ▶ Hierarchical structuring for efficient access
- ▶ May be combined with media segment or may be separate

Media Segments

- ▶ Contains the actual segmented media streams
- ▶ additional information to map segment into media presentation timeline for switching and synchronous presentation with other Representations
- ▶ For ISO BMFF, contains one or more movie fragments
- ▶ Can be short ($\approx 1-10$ sec) and long (≈ 10 sec – 2h)

Segment duration	Advantages	Disadvantages
Short	<ul style="list-style-type: none">• Suitable for live• on-demand common with live• High switching granularity on segment level	<ul style="list-style-type: none">• Large number of files• Large number of URLs• Fixed request size• switching granularity on segment level
	<ul style="list-style-type: none">• Small number of files• Small number of URLs• High switching	<ul style="list-style-type: none">• Need for Segment Index• Difference from Live

DASH Selected Features

- ▶ Live, on-demand and time-shift services
- ▶ Independency of request size and segment size (byte range requests)
- ▶ Segment formats
 - ▶ ISO base media FF and MPEG-2 TS
 - ▶ Codec independent: guidelines for integrating any other format
- ▶ Support for server and client-side component synchronization
- ▶ Support for efficient trick mode
- ▶ Simple splicing and (targeted) ad insertion
- ▶ Definition of quality metrics for logging processes
- ▶ Content Descriptors for Protection, Accessibility, Rating, etc.
- ▶ Multi-DRM support.
- ▶ Profile: restriction of DASH and system features

Profiles

- ▶ Set of restrictions on the Media Presentation (MPD & Segments)
- ▶ Permission for DASH clients that only implement the required features
- ▶ 6 Profiles defined in ISO/IEC 23009:

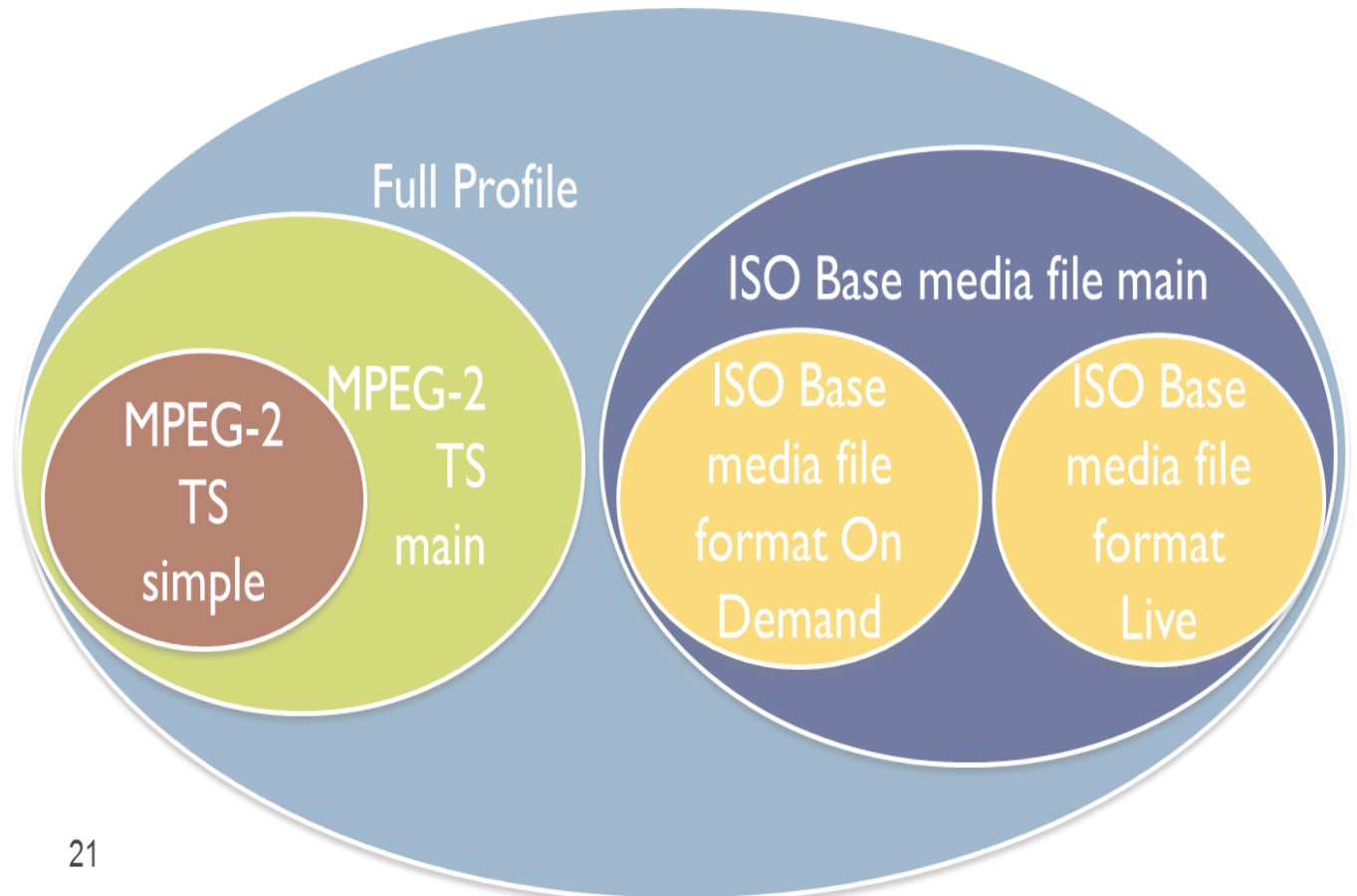

Highlighted Features

- ▶ Supports adaptive on demand and live streaming such as MPEG-4 file format and MPEG-2TS.
- ▶ Efficient and ease of use of existing CDNs, proxies, caches, NATs and firewalls.
- ▶ Control of entire streaming session by the client.
- ▶ Support of seamless switching of tracks.
- ▶ The concept of switching and selectable streams.
- ▶ Signaling, delivery, utilization of multiple DRM schemes.
- ▶ Supports ad-insertion.
- ▶ Segments with variable durations.
- ▶ Sub-segment alignment indication to simplify switching and avoiding overlapping fragments.

Highlighted Features

- ▶ Manifest fragmentation and assembly for external inclusion of elements.
- ▶ Content Descriptors for accessibility, roles, rating and camera views.
- ▶ Multiple base URLs for the same content.
- ▶ Clock drift control for live sessions.
- ▶ Scalable Video Coding (SVC) and Multiview Video Coding (MVC).
- ▶ Subsetting of representation groups according to the content author's guidance.
- ▶ Quality metrics for reporting the session experience.